

# Advent of Code

— 2024 —

*by Lord Baryhobal*

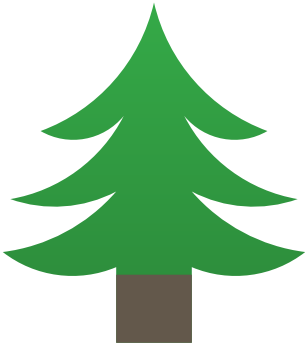

Stars: 21 / 50

Mon	Tue	Wed	Thu	Fri	Sat	Sun
						1 ★★
2 ★★	3 ★★	4 ★★	5 ★★	6 ★★	7 ★★	8 ★★
9 ★★	10 ★★	11 ★	12	13	14	15
16	17	18	19	20	21	22
23	24	25				

## Contents

Day 1★★	3
Puzzle 1	3
Puzzle 2	3
Day 2★★	4
Puzzle 1	4
Puzzle 2	4
Day 3★★	5
Puzzle 1	5
Puzzle 2	5
Day 4★★	6
Puzzle 1	6
Puzzle 2	6
Day 5★★	7
Puzzle 1	7
Puzzle 2	7
Day 6★★	8
Puzzle 1	8
Puzzle 2	8
Day 7★★	9
Puzzle 1	9
Puzzle 2	9
Day 8★★	10
Puzzle 1	10
Puzzle 2	10
Day 9★★	11
Puzzle 1	11
Puzzle 2	11
Day 10★★	12
Puzzle 1	12
Puzzle 2	12
Day 11★	13
Puzzle 1	13
Puzzle 2	13

## Day 1 ★★

### Puzzle 1

Example passes

Result: 2113135

### Puzzle 2

Example passes

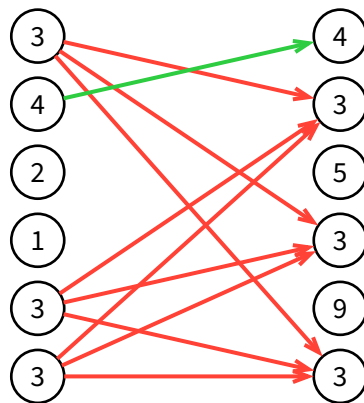

Figure 1: Example (visualization)

Result: 19097157

## Day 2 ★★

### Puzzle 1

Example passes

Result: 660

### Puzzle 2

Example passes

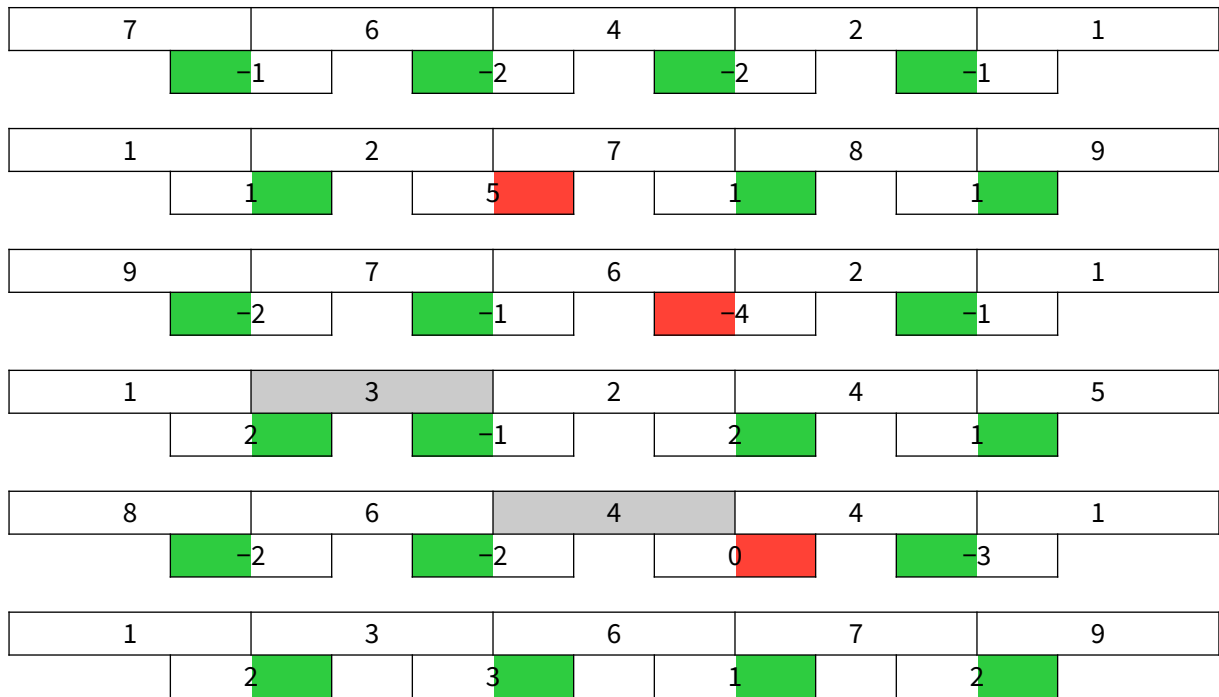

Figure 2: Example (visualization)

Result: 689



## Day 4★★

### Puzzle 1

Example passes

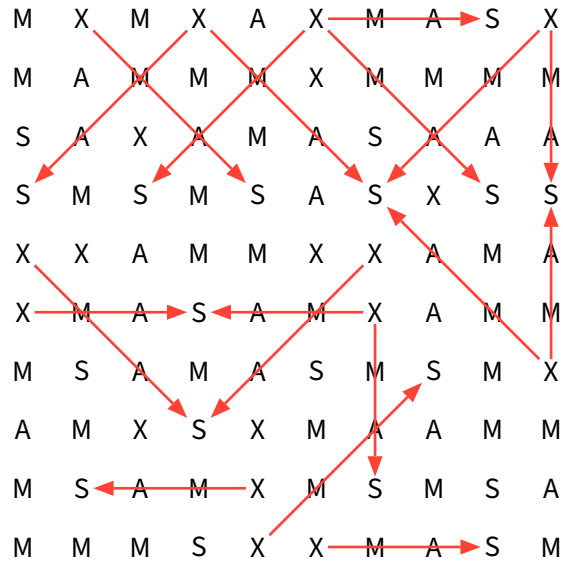

Figure 3: Example (visualization)

Result: 2654

### Puzzle 2

Example passes

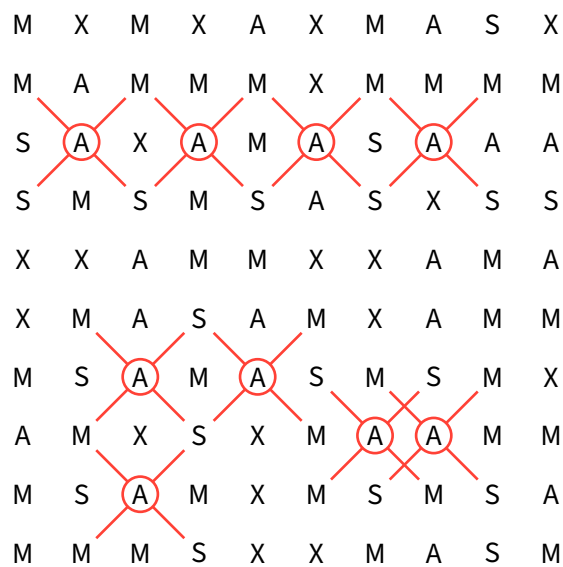

Figure 4: Example (visualization)

Result: 1990

# Day 5 ★★

## Puzzle 1

Example passes

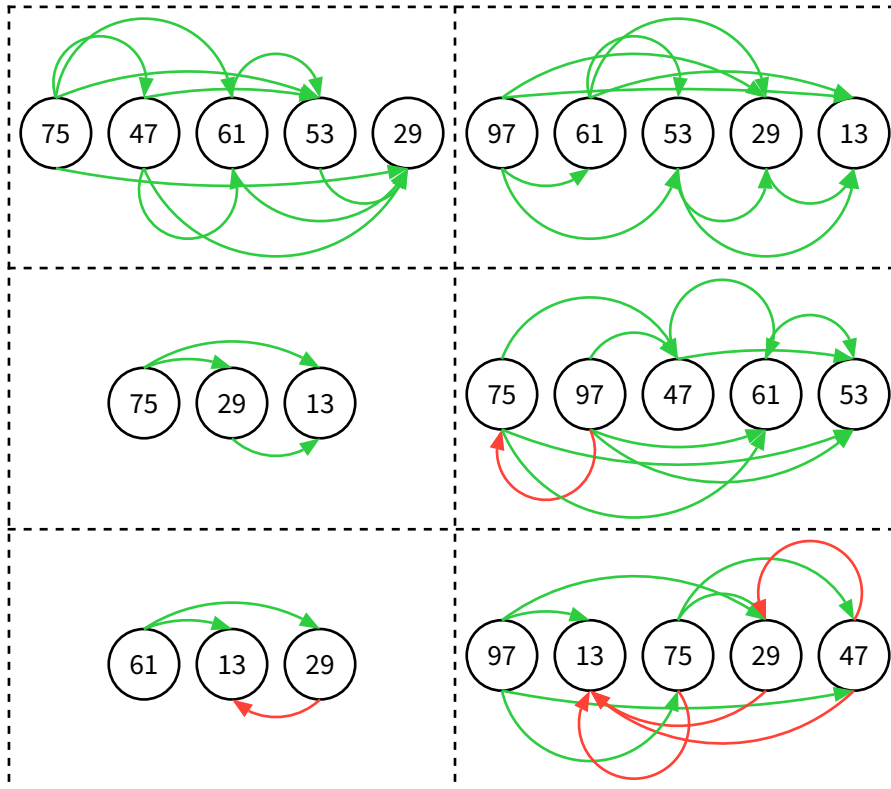

Figure 5: Example (visualization)

Result: 5374

## Puzzle 2

Example passes

Result: 4260

## Day 6 ★★

### Puzzle 1

Example passes

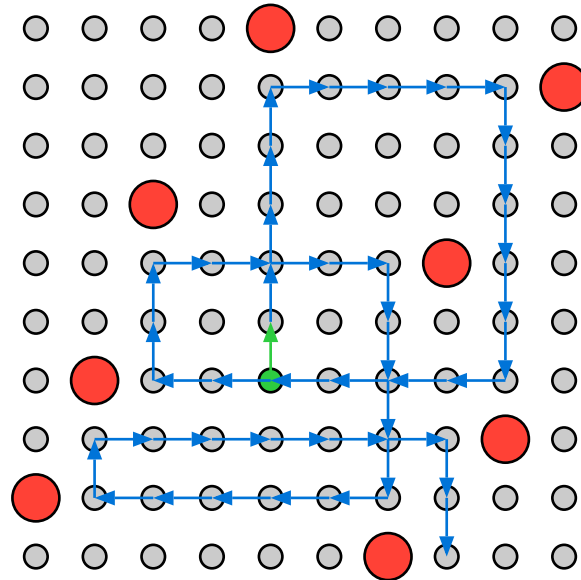

Figure 6: Example (visualization)

Result: 4752

### Puzzle 2

Example passes

Result: 1719



# Day 7★★

## Puzzle 1

Example passes

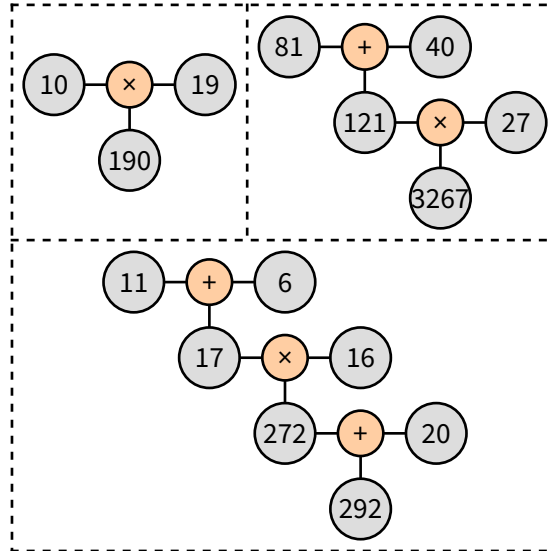

Figure 7: Example (visualization)

Result: 850435817339

## Puzzle 2

Example passes

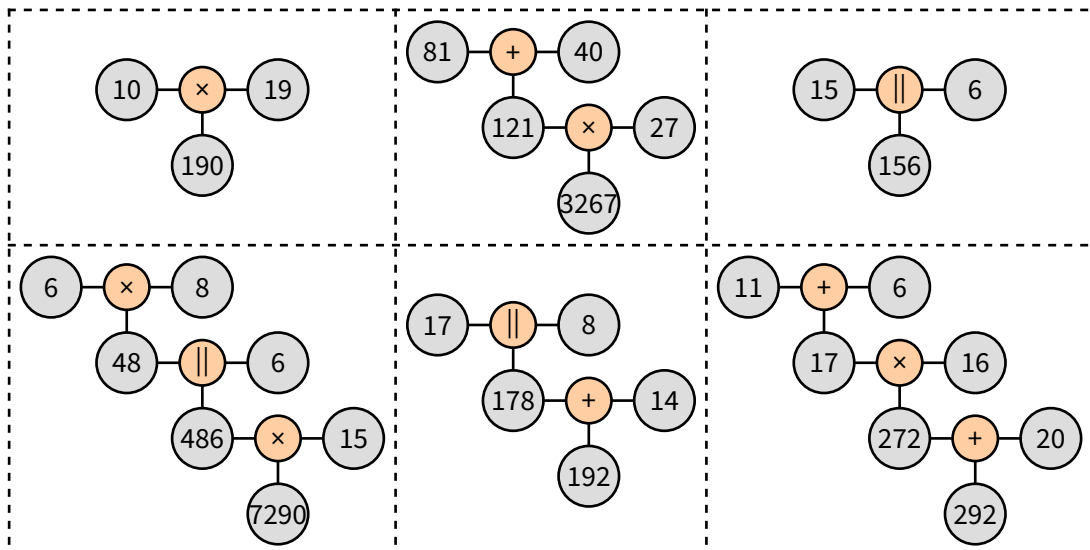

Figure 8: Example (visualization)

Result: 104824810233437

## Day 8 ★★

### Puzzle 1

Example passes

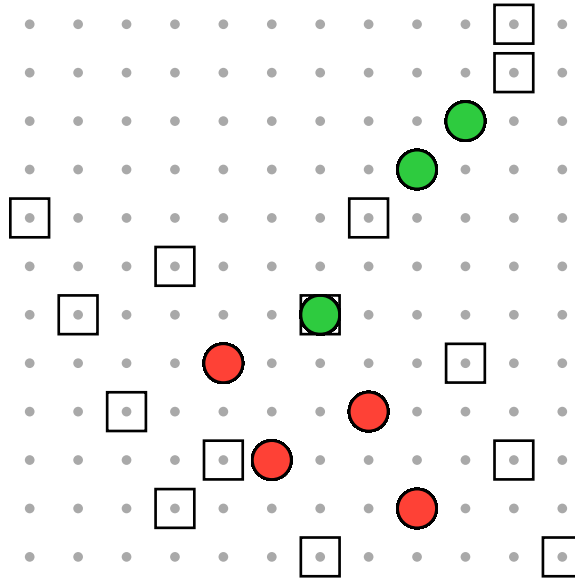

Figure 9: Example (visualization)

Result: 265

### Puzzle 2

Example passes

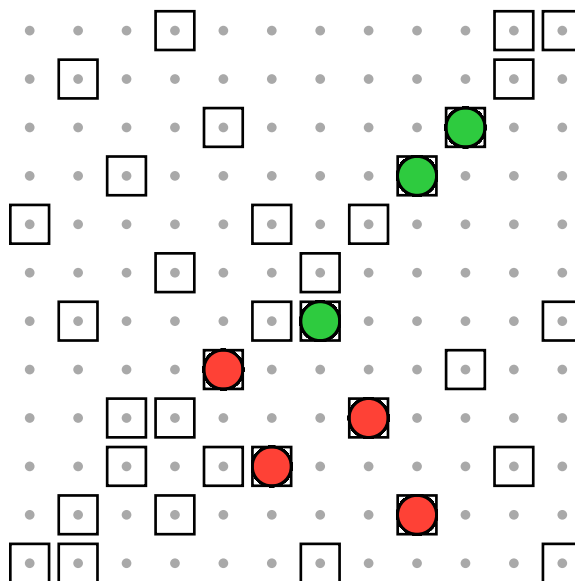

Figure 10: Example (visualization)

Result: 962

# Day 9☆☆

## Puzzle 1

Example '1' passes

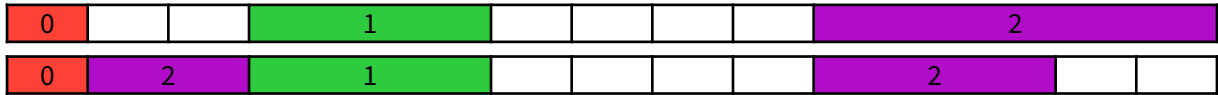

Figure 11: Example '1' (visualization)

Example '2' passes

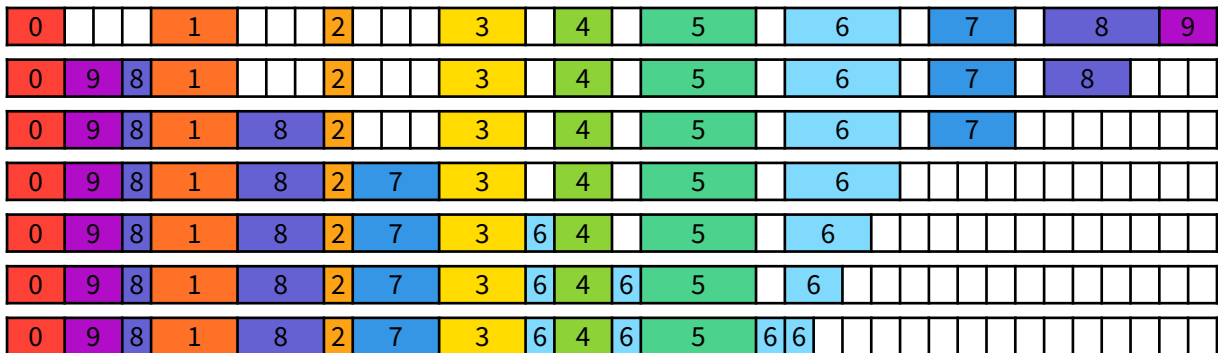

Figure 12: Example '2' (visualization)

Result: 6390180901651

## Puzzle 2

Example '1' passes

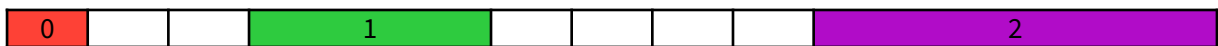

Figure 13: Example '1' (visualization)

Example '2' passes

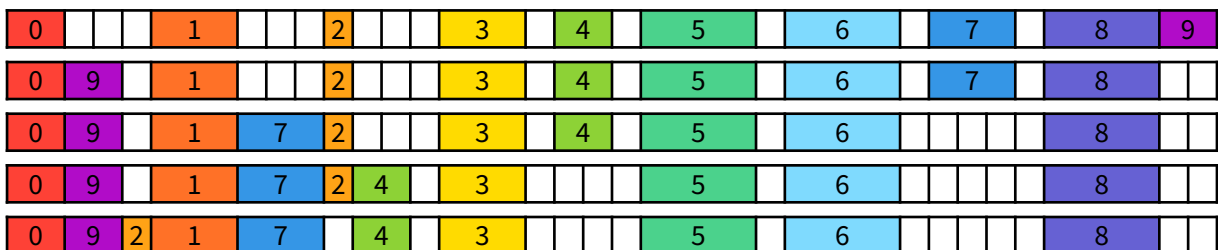

Figure 14: Example '2' (visualization)

Result: 6412390114238

## Day 10 ★★

### Puzzle 1

Example passes

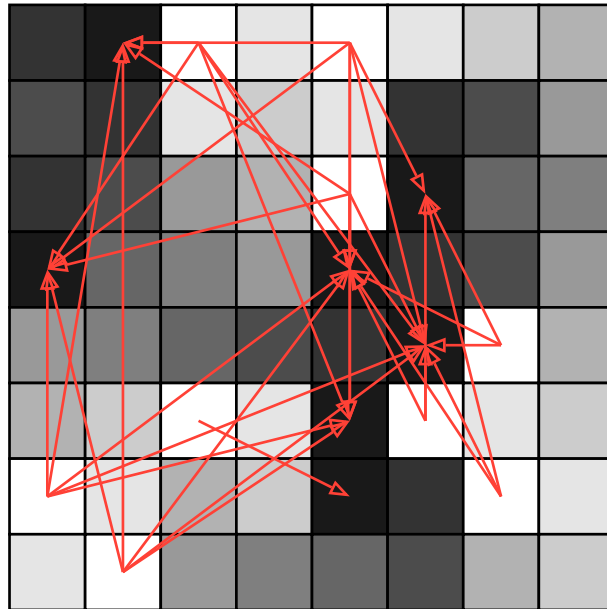

Figure 15: Example (visualization)

Result: 825

### Puzzle 2

Example passes

Result: 1805

## Day 11

### Puzzle 1

Example passes

Result: 191690

### Puzzle 2