

Advent of Code

— 2024 —

by Lord Baryhobal

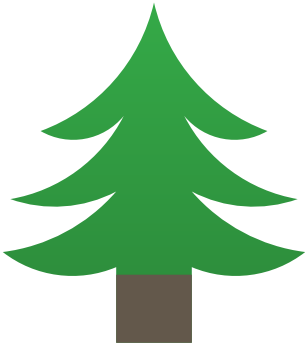

Stars: 31 / 50

Mon	Tue	Wed	Thu	Fri	Sat	Sun
						1 ★★
2 ★★	3 ★★	4 ★★	5 ★★	6 ★★	7 ★★	8 ★★
9 ★★	10 ★★	11 ★★	12 ★★	13 ★★	14 ★★	15 ★★
16	17 ★	18	19	20	21	22
23	24	25				

Contents

Day 1★★	3	Puzzle 1	17
Puzzle 1	3	Puzzle 2	17
Puzzle 2	3	Day 16	18
Day 2★★	4	Puzzle 1	18
Puzzle 1	4	Puzzle 2	18
Puzzle 2	4	Day 17★	19
Day 3★★	5	Puzzle 1	19
Puzzle 1	5	Puzzle 2	19
Puzzle 2	5		
Day 4★★	6		
Puzzle 1	6		
Puzzle 2	6		
Day 5★★	7		
Puzzle 1	7		
Puzzle 2	7		
Day 6★★	8		
Puzzle 1	8		
Puzzle 2	8		
Day 7★★	9		
Puzzle 1	9		
Puzzle 2	9		
Day 8★★	10		
Puzzle 1	10		
Puzzle 2	10		
Day 9★★	11		
Puzzle 1	11		
Puzzle 2	11		
Day 10★★	12		
Puzzle 1	12		
Puzzle 2	12		
Day 11★★	13		
Puzzle 1	13		
Puzzle 2	13		
Day 12★★	14		
Puzzle 1	14		
Puzzle 2	14		
Day 13★★	15		
Puzzle 1	15		
Puzzle 2	15		
Day 14★★	16		
Puzzle 1	16		
Puzzle 2	16		
Day 15★★	17		

Day 1 ★★

Puzzle 1

Example passes

Result: 2113135

Puzzle 2

Example passes

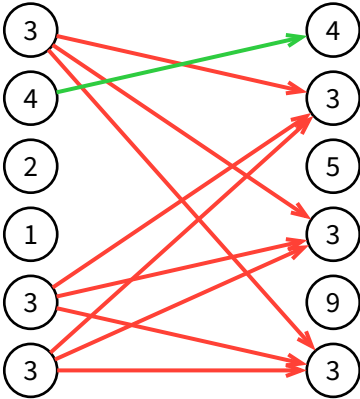

Figure 1: Example (visualization)

Result: 19097157

Day 2 ★★

Puzzle 1

Example passes

Result: 660

Puzzle 2

Example passes

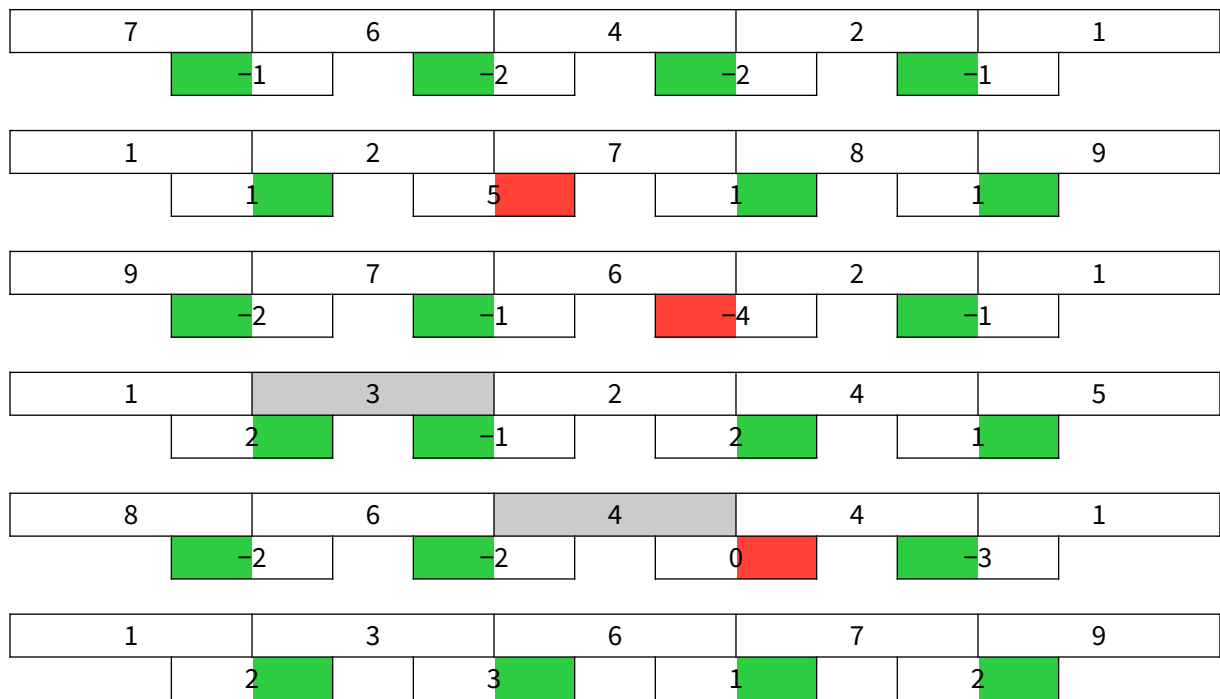

Figure 2: Example (visualization)

Result: 689

Day 3☆☆

Puzzle 1

Example '1' passes

$x \underbrace{\text{mul}(2,4)}_8 \% \text{mul}[3,7] ! @ \text{do_not_} \underbrace{\text{mul}(5,5)}_{25} + \text{mul}(32,64) \text{ then } (\underbrace{\text{mul}(11,8)}_{88} \underbrace{\text{mul}(8,5)}_{40})$

Listing 1: Example '1' (visualization)

Result: 187825547

Puzzle 2

Example '2' passes

Result: 85508223

Day 4★★

Puzzle 1

Example passes

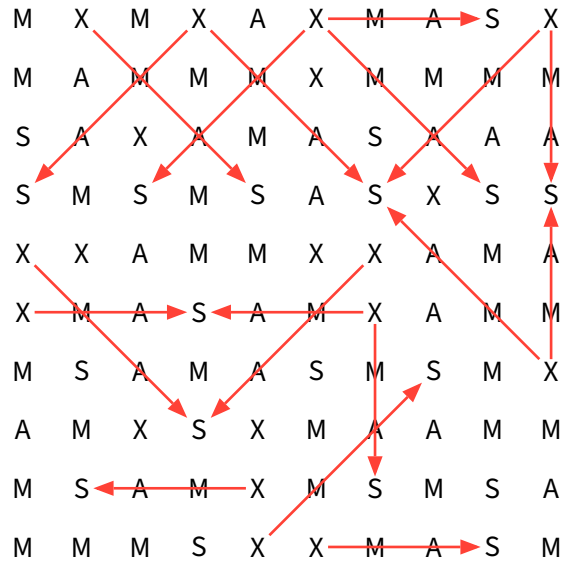

Figure 3: Example (visualization)

Result: 2654

Puzzle 2

Example passes

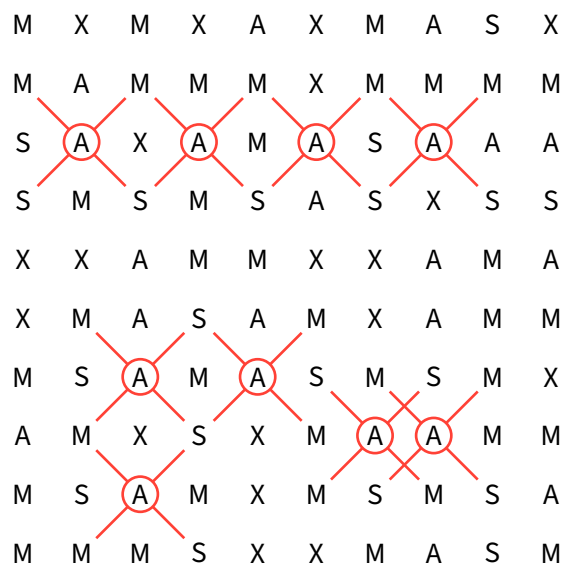

Figure 4: Example (visualization)

Result: 1990

Day 5 ★★

Puzzle 1

Example passes

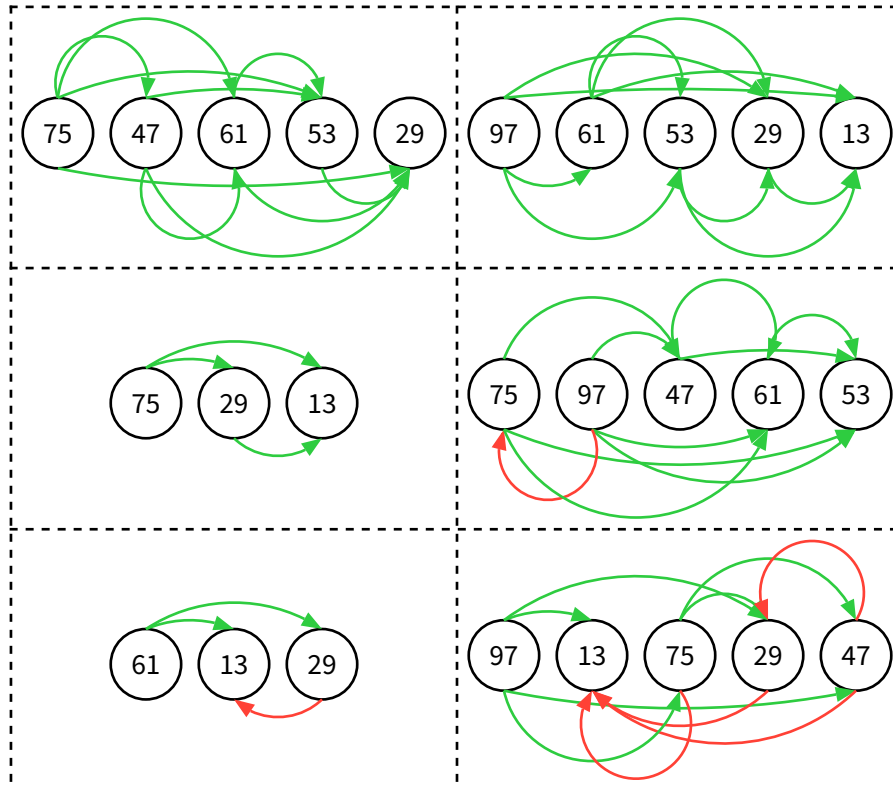

Figure 5: Example (visualization)

Result: 5374

Puzzle 2

Example passes

Result: 4260

Day 6 ★★

Puzzle 1

Example passes

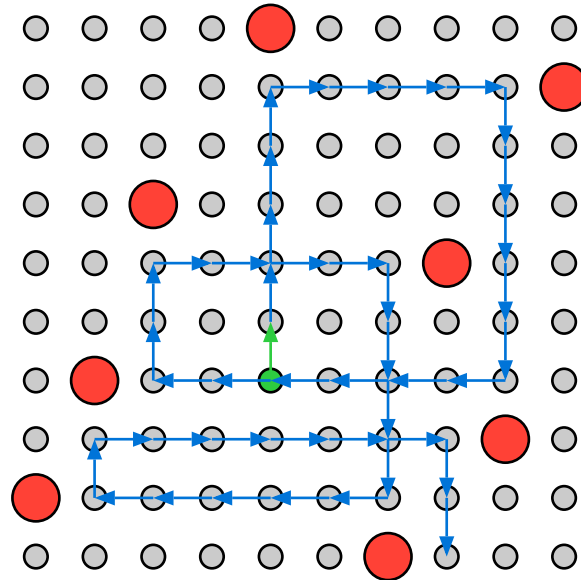

Figure 6: Example (visualization)

Result: 4752

Puzzle 2

Example passes

Result: 1719

Day 7★★

Puzzle 1

Example passes

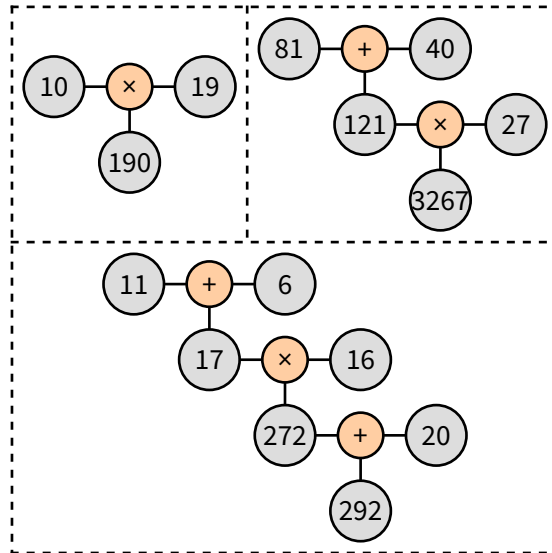

Result: 850435817339

Puzzle 2

Example passes

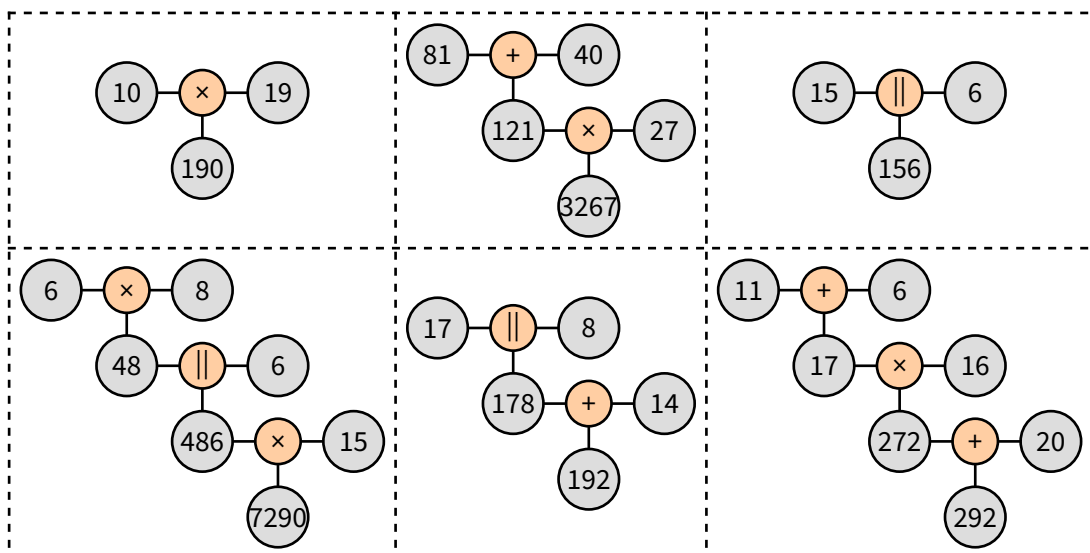

Result: 104824810233437

Day 8 ★★

Puzzle 1

Example passes

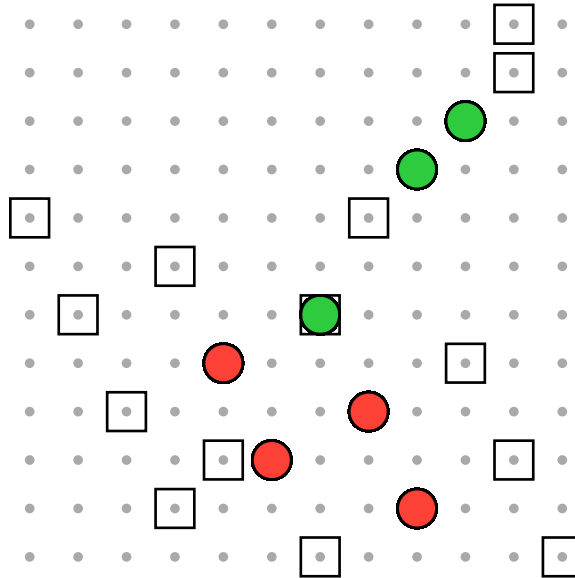

Figure 9: Example (visualization)

Result: 265

Puzzle 2

Example passes

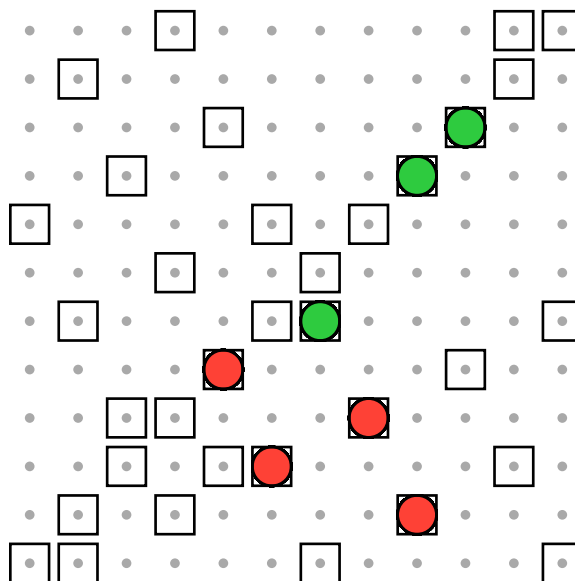

Figure 10: Example (visualization)

Result: 962

Day 9 ★★

Puzzle 1

Example '1' passes

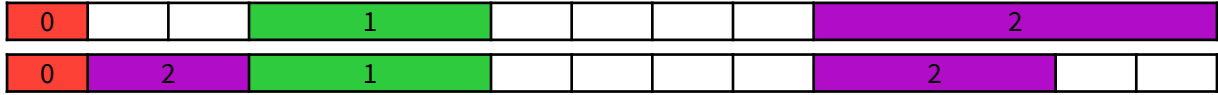

Figure 11: Example '1' (visualization)

Example '2' passes



Figure 12: Example '2' (visualization)

Result: 6390180901651

Puzzle 2

Example '1' passes

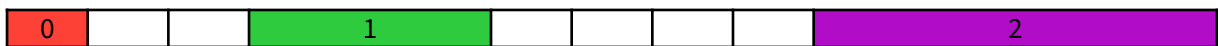

Figure 13: Example '1' (visualization)

Example '2' passes

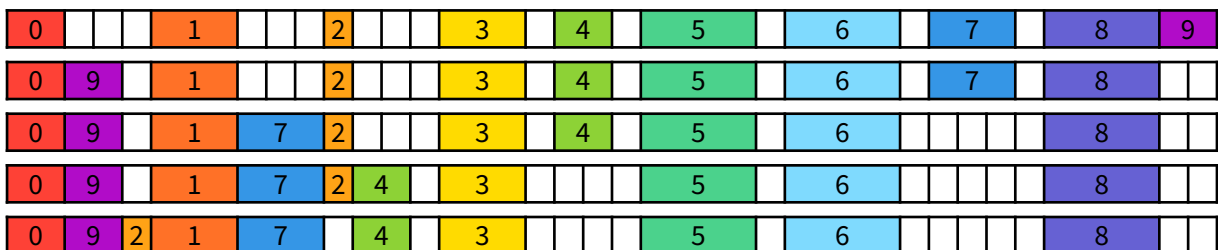

Figure 14: Example '2' (visualization)

Result: 6412390114238

Day 10 ★★

Puzzle 1

Example passes

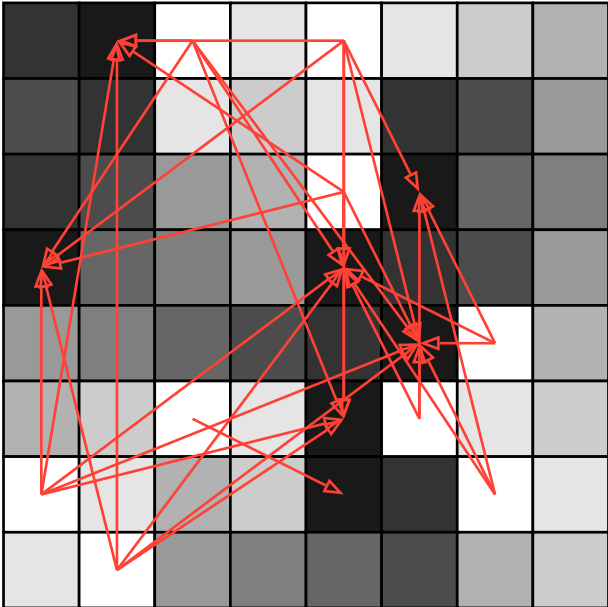

Figure 15: Example (visualization)

Result: 825

Puzzle 2

Example passes

Result: 1805

Day 11 ★★

Puzzle 1

Example passes

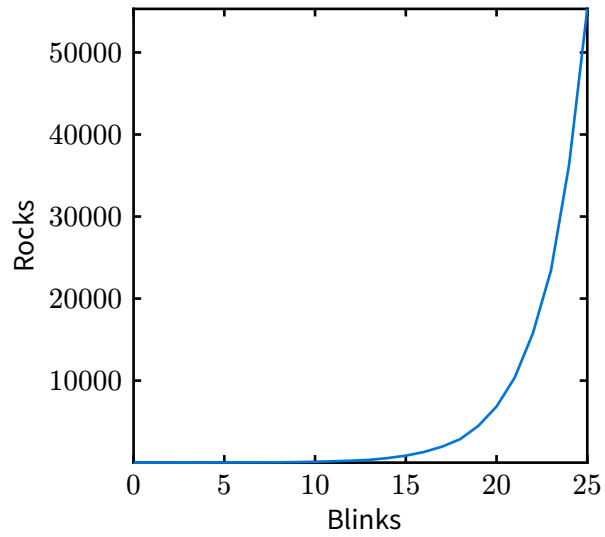

Figure 16: Example (visualization)

Result: 191690

Puzzle 2

Result: 228651922369703

Day 12 ★★

Puzzle 1

Example '1' passes

Example '2' passes

Example '3' passes

Result: 1450422

Puzzle 2

Example '1' passes

Example '2' passes

Example '3' passes

Example '4' passes

Example '5' passes

Result: 906606

Day 13 ★★

Puzzle 1

Example passes

Result: 29438

Puzzle 2

Example passes

Result: 104958599303720

Day 14 ★★

Puzzle 1

Example passes

Result: 230436441

Puzzle 2

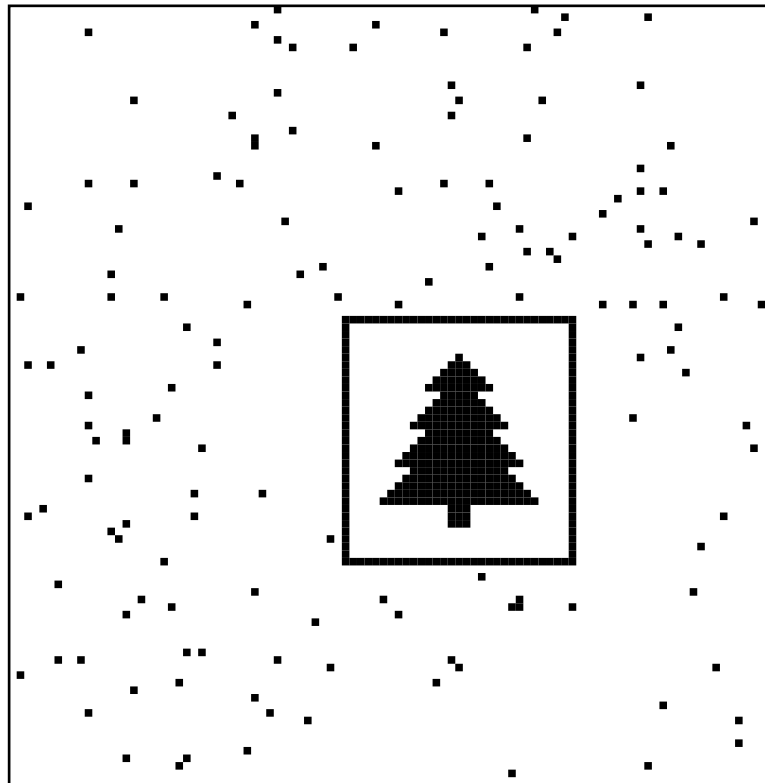

Figure 17: Christmas tree easter egg

Result: 8270

Day 15 ★★

Puzzle 1

Example '1' passes

Example '2' passes

Result: 1526018

Puzzle 2

Example '2' passes

Result: 1550677

Day 16

Puzzle 1

Example '1' fails

Expected '7036' got '0'

Example '2' fails

Expected '11048' got '0'

Result: 0

Puzzle 2

Day 17★

Puzzle 1

Example '1' passes

Result: "2,7,6,5,6,0,2,3,1"

Puzzle 2

Example:

0,3,5,4,3,0

ADV: A >>= 3

OUT: OUT(A & 0b111)

JNZ: IF A != 0 {PC = 0}

Input:

2,4,1,5,7,5,1,6,4,2,5,5,0,3,3,0

BST: B = A & 0b111

BXL: B ^= 5

CDV: C = A >> B

BXL: B ^= 6

BXC: B ^= C

OUT: OUT(B & 0b111)

ADV: A >>= 3

JNZ: IF A != 0 {PC = 0}