

Advent of Code

— 2024 —

by Lord Baryhobal

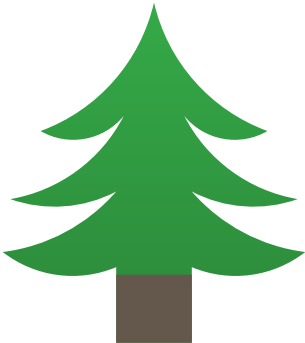

Stars: 14 / 50

Mon	Tue	Wed	Thu	Fri	Sat	Sun
						1 ★★
2 ★★	3 ★★	4 ★★	5 ★★	6 ★★	7 ★★	8
9	10	11	12	13	14	15
16	17	18	19	20	21	22
23	24	25				

Contents

Day 1★★	3
Puzzle 1	3
Puzzle 2	3
Day 2★★	4
Puzzle 1	4
Puzzle 2	4
Day 3★★	5
Puzzle 1	5
Puzzle 2	5
Day 4★★	6
Puzzle 1	6
Puzzle 2	6
Day 5★★	7
Puzzle 1	7
Puzzle 2	7
Day 6★★	8
Puzzle 1	8
Puzzle 2	8
Day 7★★	9
Puzzle 1	9
Puzzle 2	9

Day 1 ★★

Puzzle 1

Example passes

Result: 2113135

Puzzle 2

Example passes

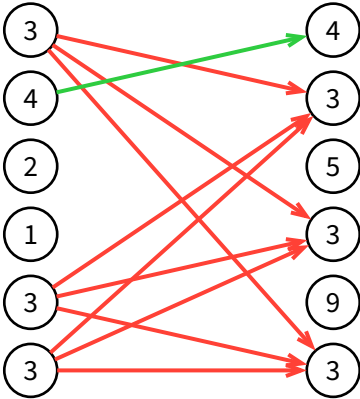

Figure 1: Example (visualization)

Result: 19097157

Day 2 ★★

Puzzle 1

Example passes

Result: 660

Puzzle 2

Example passes

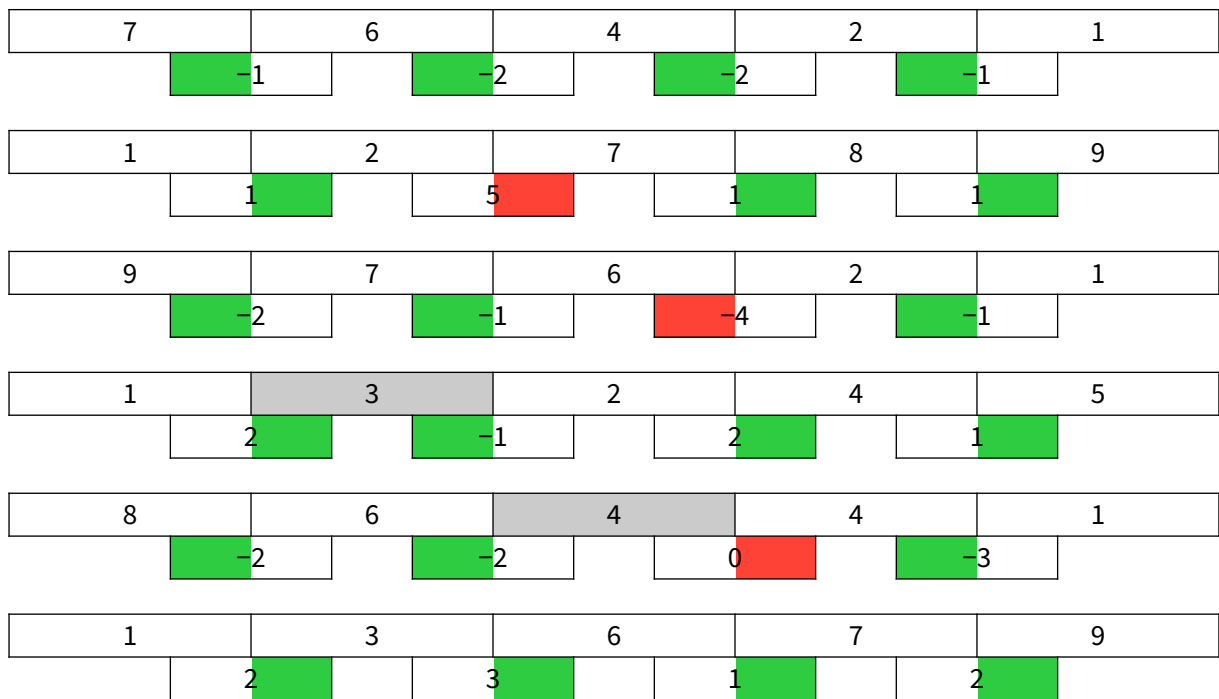

Figure 2: Example (visualization)

Result: 689

Day 4★★

Puzzle 1

Example passes

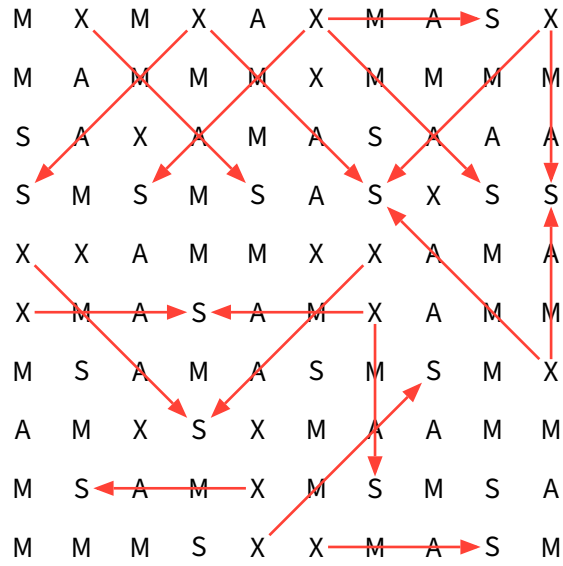

Figure 3: Example (visualization)

Result: 2654

Puzzle 2

Example passes

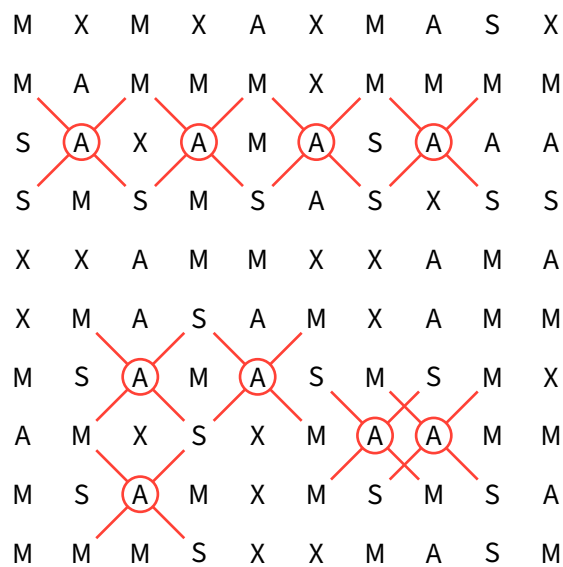

Figure 4: Example (visualization)

Result: 1990

Day 5 ★★

Puzzle 1

Example passes

Result: 5374

Puzzle 2

Example passes

Result: 4260

Day 7★★

Puzzle 1

Example passes

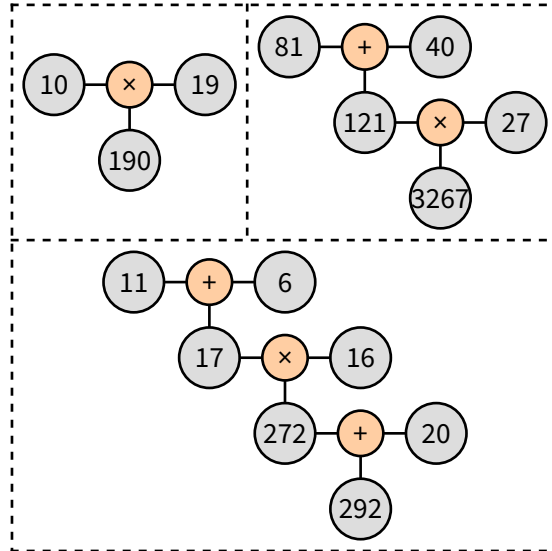

Figure 6: Example (visualization)

Result: 850435817339

Puzzle 2

Example passes

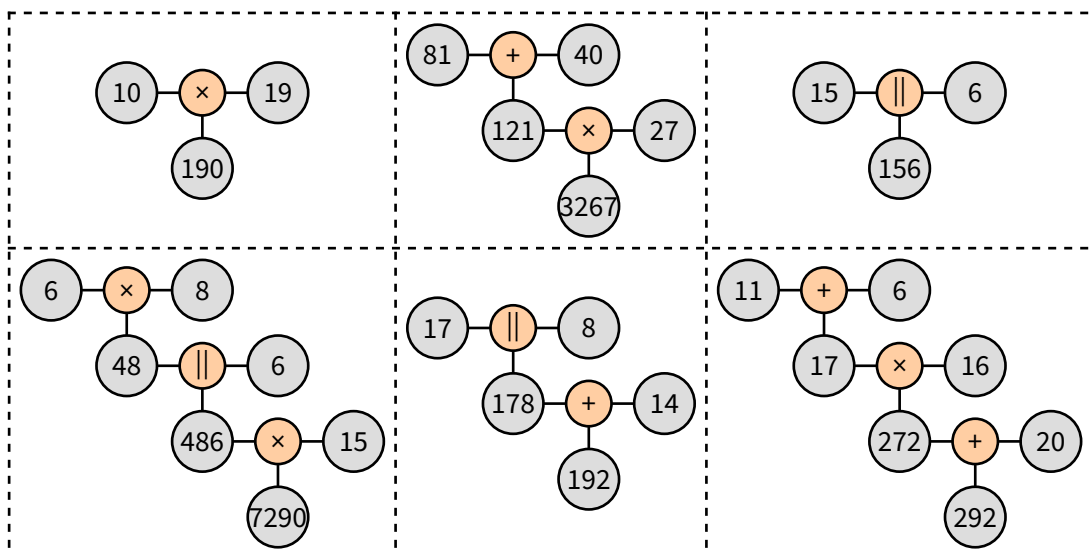

Figure 7: Example (visualization)

Result: 104824810233437