

Advent of Code

— 2024 —

by Lord Baryhobal

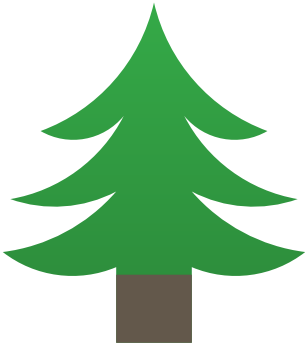

Stars: 29 / 50

Mon	Tue	Wed	Thu	Fri	Sat	Sun
						1 ★★
2 ★★	3 ★★	4 ★★	5 ★★	6 ★★	7 ★★	8 ★★
9 ★★	10 ★★	11 ★★	12 ★★	13 ★★	14 ★★	15 ★
16	17	18	19	20	21	22
23	24	25				

Contents

Day 1★★	3
Puzzle 1	3
Puzzle 2	3
Day 2★★	4
Puzzle 1	4
Puzzle 2	4
Day 3★★	5
Puzzle 1	5
Puzzle 2	5
Day 4★★	6
Puzzle 1	6
Puzzle 2	6
Day 5★★	7
Puzzle 1	7
Puzzle 2	7
Day 6★★	8
Puzzle 1	8
Puzzle 2	8
Day 7★★	9
Puzzle 1	9
Puzzle 2	9
Day 8★★	10
Puzzle 1	10
Puzzle 2	10
Day 9★★	11
Puzzle 1	11
Puzzle 2	11
Day 10★★	12
Puzzle 1	12
Puzzle 2	12
Day 11★★	13
Puzzle 1	13
Puzzle 2	13
Day 12★★	14
Puzzle 1	14
Puzzle 2	14
Day 13★★	15
Puzzle 1	15
Puzzle 2	15
Day 14★★	16
Puzzle 1	16
Puzzle 2	16
Day 15★	17

Puzzle 1	17
Puzzle 2	17

Day 1 ★★

Puzzle 1

Example passes

Result: 2113135

Puzzle 2

Example passes

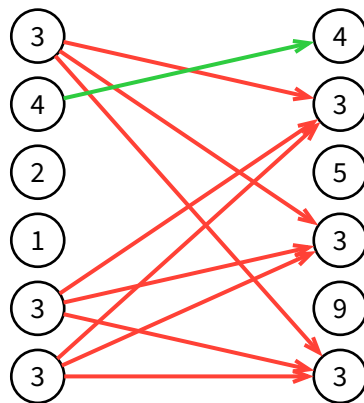

Figure 1: Example (visualization)

Result: 19097157

Day 2 ★★

Puzzle 1

Example passes

Result: 660

Puzzle 2

Example passes

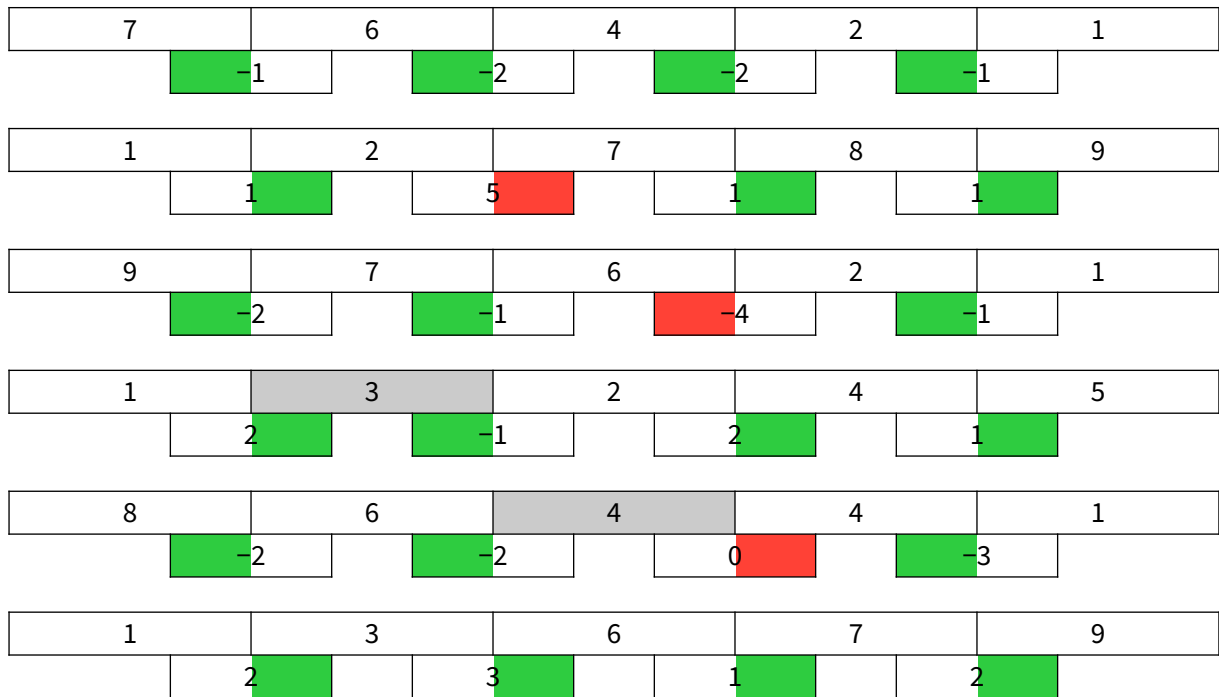

Figure 2: Example (visualization)

Result: 689

Day 4★★

Puzzle 1

Example passes

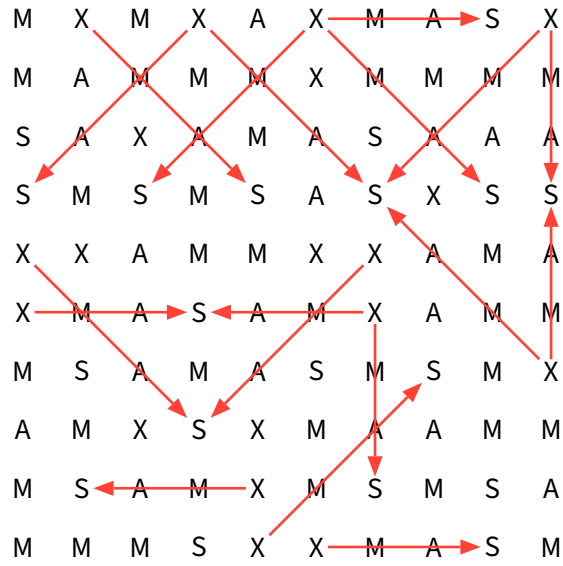

Figure 3: Example (visualization)

Result: 2654

Puzzle 2

Example passes

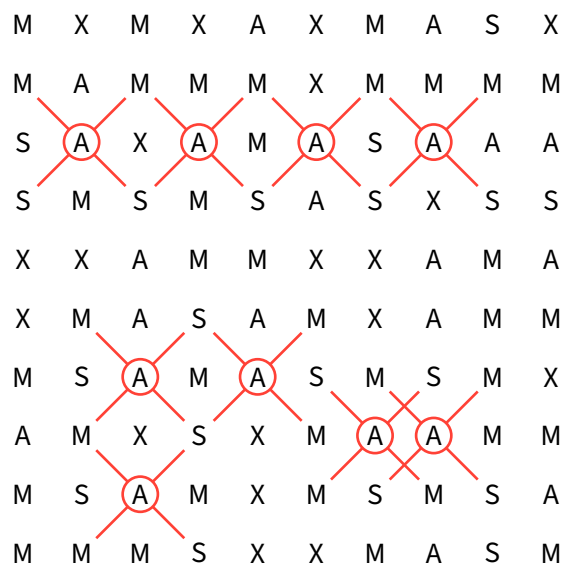

Figure 4: Example (visualization)

Result: 1990

Day 5 ★★

Puzzle 1

Example passes

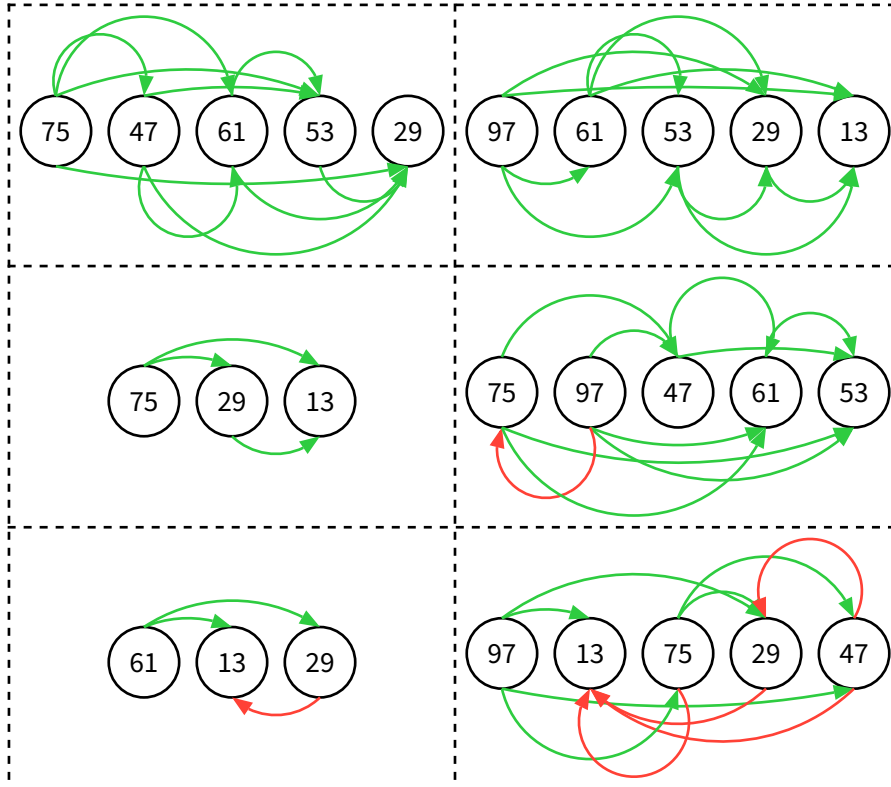

Figure 5: Example (visualization)

Result: 5374

Puzzle 2

Example passes

Result: 4260

Day 7★★

Puzzle 1

Example passes

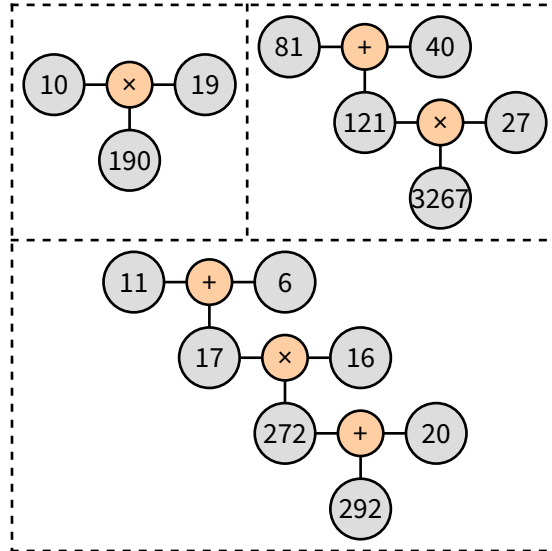

Result: 850435817339

Puzzle 2

Example passes

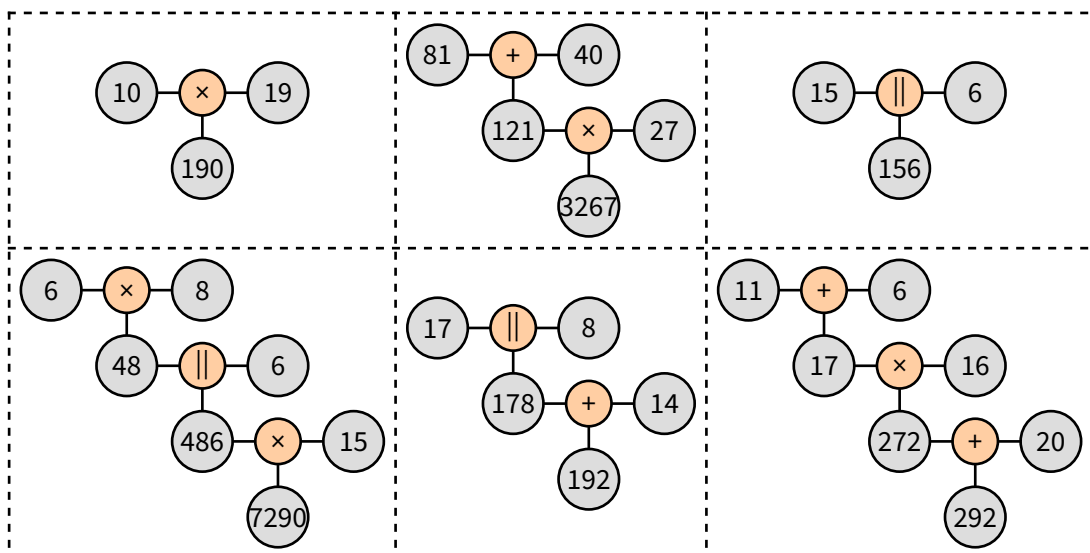

Result: 104824810233437

Day 8 ★★

Puzzle 1

Example passes

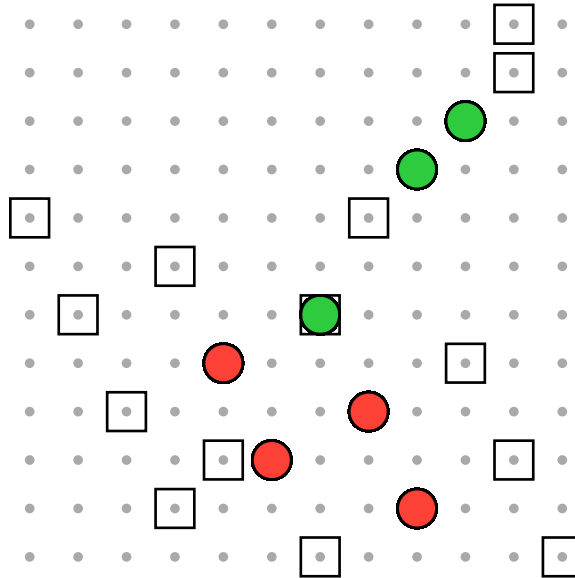

Figure 9: Example (visualization)

Result: 265

Puzzle 2

Example passes

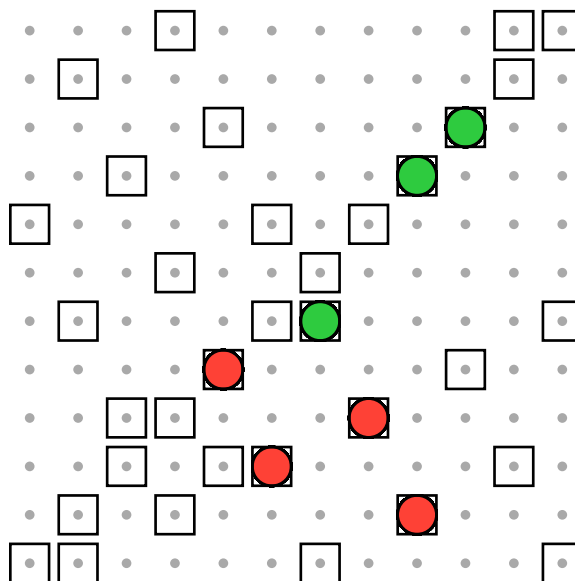

Figure 10: Example (visualization)

Result: 962

Day 9 ★★

Puzzle 1

Example '1' passes

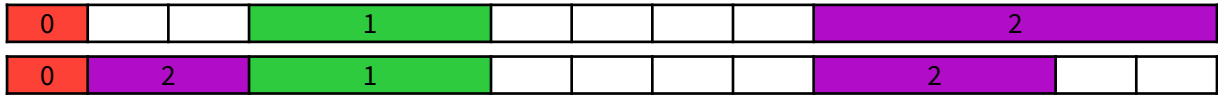

Figure 11: Example '1' (visualization)

Example '2' passes

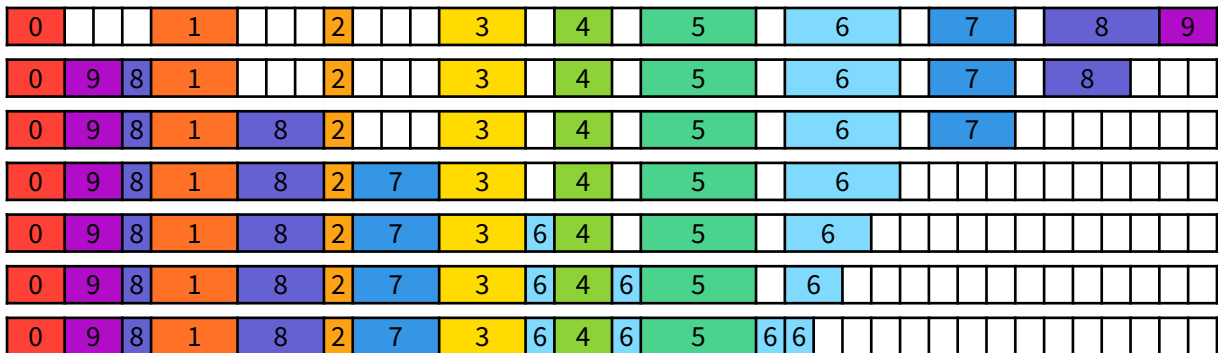

Figure 12: Example '2' (visualization)

Result: 6390180901651

Puzzle 2

Example '1' passes

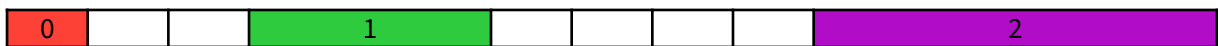

Figure 13: Example '1' (visualization)

Example '2' passes

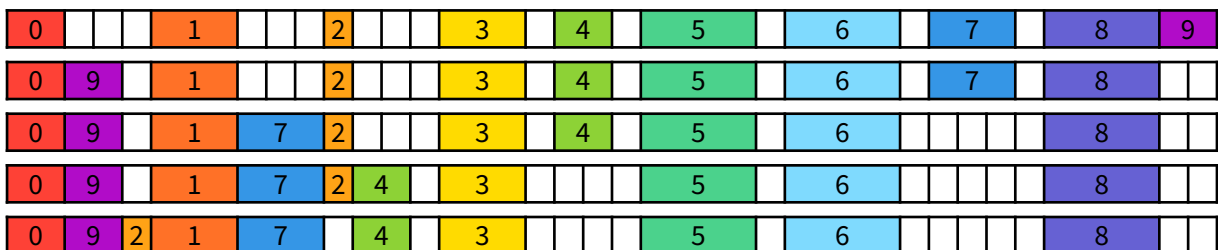

Figure 14: Example '2' (visualization)

Result: 6412390114238

Day 10 ★★

Puzzle 1

Example passes

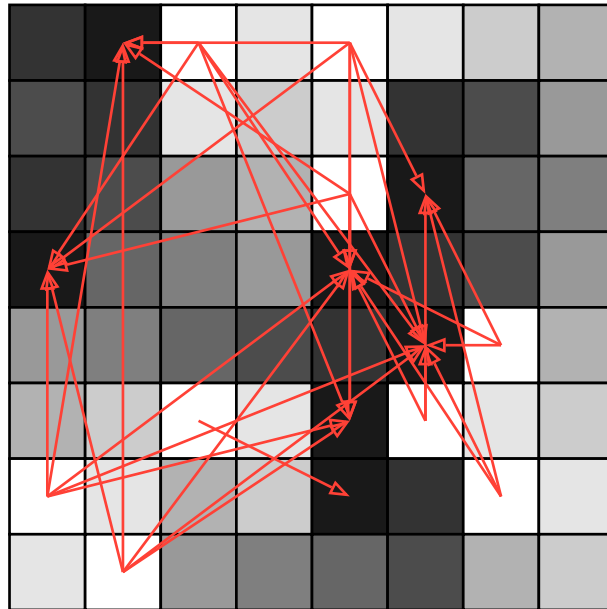

Figure 15: Example (visualization)

Result: 825

Puzzle 2

Example passes

Result: 1805

Day 11 ★★

Puzzle 1

Example passes

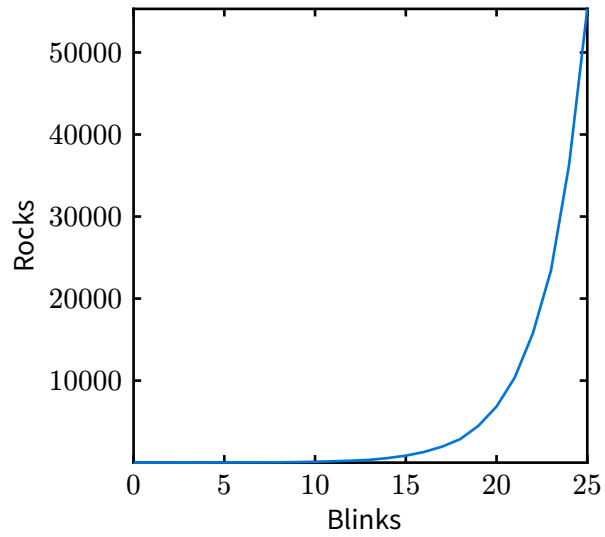

Figure 16: Example (visualization)

Result: 191690

Puzzle 2

Result: 228651922369703

Day 12 ★★

Puzzle 1

Example '1' passes

Example '2' passes

Example '3' passes

Result: 1450422

Puzzle 2

Example '1' passes

Example '2' passes

Example '3' passes

Example '4' passes

Example '5' passes

Result: 906606

Day 13 ★★

Puzzle 1

Example passes

Result: 29438

Puzzle 2

Example passes

Result: 104958599303720

Day 14 ★★

Puzzle 1

Example passes

Result: 230436441

Puzzle 2

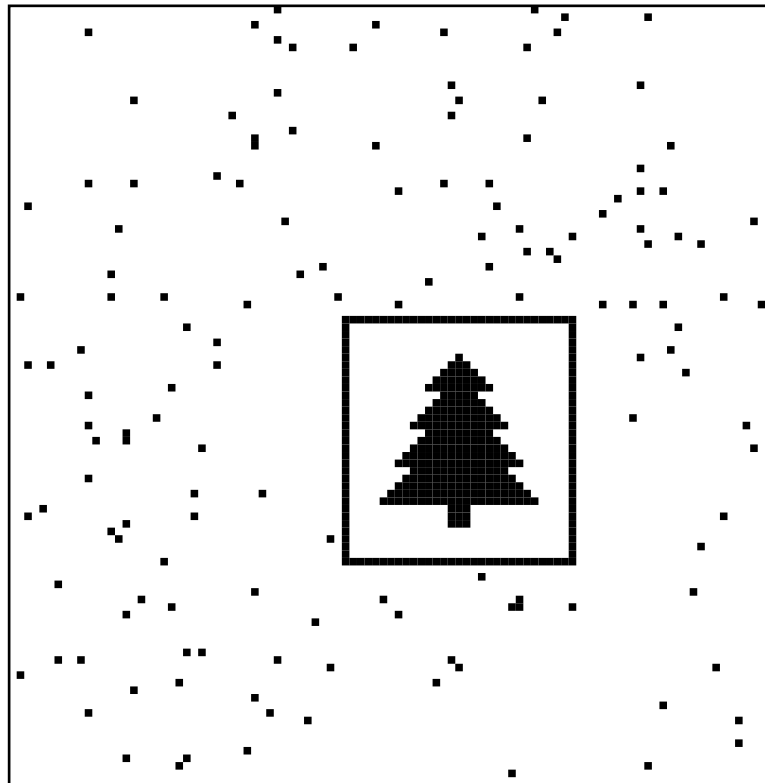

Figure 17: Christmas tree easter egg

Result: 8270

Day 15★

Puzzle 1

Example '1' passes

Example '2' passes

Result: 1526018

Puzzle 2

Example '2' passes

Result: 1550677