

# Advent of Code

— 2024 —

*by Lord Baryhobal*

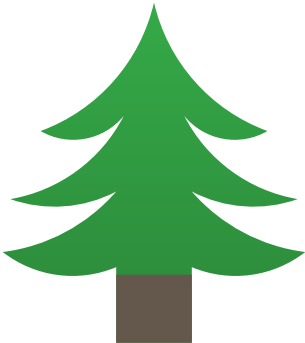

Stars: 39 / 50

Mon	Tue	Wed	Thu	Fri	Sat	Sun
						1 ★★
2 ★★	3 ★★	4 ★★	5 ★★	6 ★★	7 ★★	8 ★★
9 ★★	10 ★★	11 ★★	12 ★★	13 ★★	14 ★★	15 ★★
16	17 ★	18 ★★	19 ★★	20 ★	21	22 ★
23 ★★	24	25				

## Contents

Day 1★★	3	Puzzle 1	17
Puzzle 1	3	Puzzle 2	17
Puzzle 2	3	Day 16	18
Day 2★★	4	Puzzle 1	18
Puzzle 1	4	Puzzle 2	18
Puzzle 2	4	Day 17★	19
Day 3★★	5	Puzzle 1	19
Puzzle 1	5	Puzzle 2	19
Puzzle 2	5	Day 18★★	20
Day 4★★	6	Puzzle 1	20
Puzzle 1	6	Puzzle 2	20
Puzzle 2	6	Day 19★★	21
Day 5★★	7	Puzzle 1	21
Puzzle 1	7	Puzzle 2	21
Puzzle 2	7	Day 20★	22
Day 6★★	8	Puzzle 1	22
Puzzle 1	8	Puzzle 2	22
Puzzle 2	8	Day 21	23
Day 7★★	9	Puzzle 1	23
Puzzle 1	9	Puzzle 2	23
Puzzle 2	9	Day 22★	24
Day 8★★	10	Puzzle 1	24
Puzzle 1	10	Puzzle 2	24
Puzzle 2	10	Day 23★★	25
Day 9★★	11	Puzzle 1	25
Puzzle 1	11	Puzzle 2	25
Puzzle 2	11		
Day 10★★	12		
Puzzle 1	12		
Puzzle 2	12		
Day 11★★	13		
Puzzle 1	13		
Puzzle 2	13		
Day 12★★	14		
Puzzle 1	14		
Puzzle 2	14		
Day 13★★	15		
Puzzle 1	15		
Puzzle 2	15		
Day 14★★	16		
Puzzle 1	16		
Puzzle 2	16		
Day 15★★	17		

Day 1 ★★

Puzzle 1

Example passes

Result: 2113135

Puzzle 2

Example passes

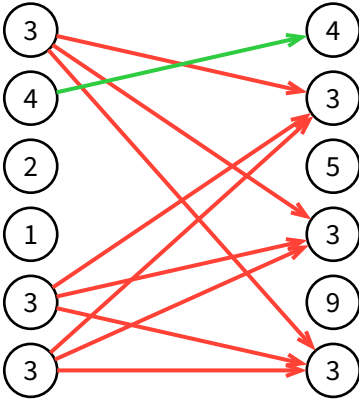

Figure 1: Example (visualization)

Result: 19097157

## Day 2 ★★

### Puzzle 1

Example passes

Result: 660

### Puzzle 2

Example passes

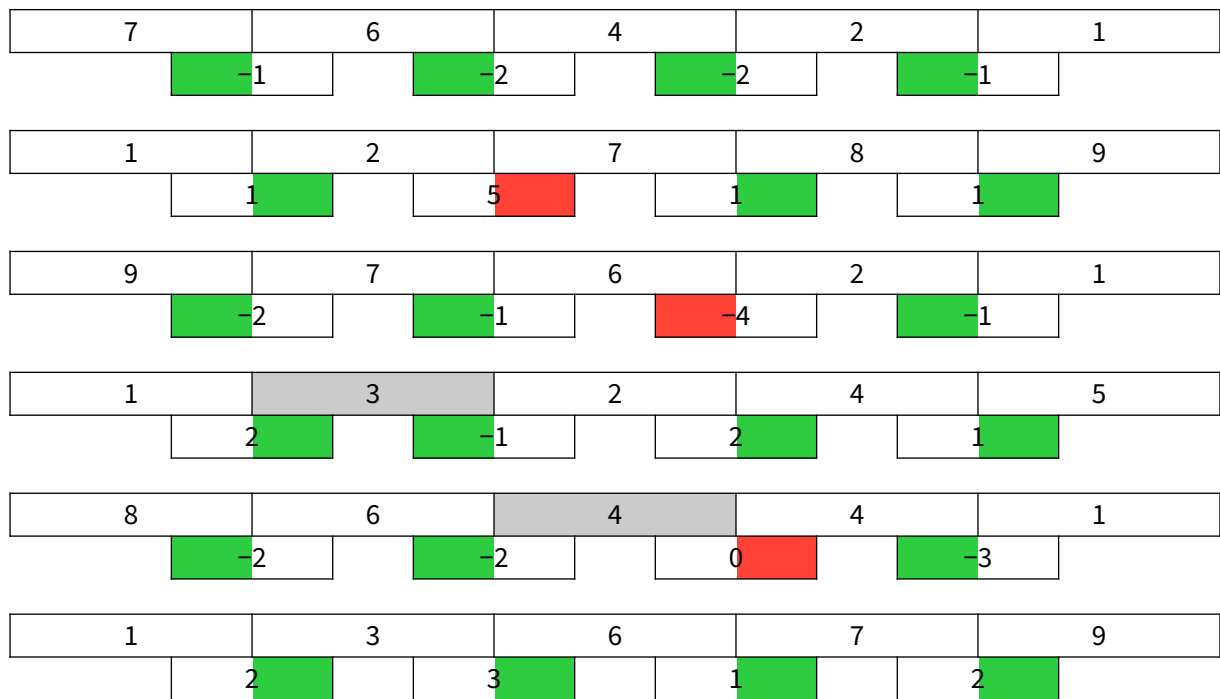

Figure 2: Example (visualization)

Result: 689

# Day 3☆☆

## Puzzle 1

Example '1' passes

x mul(2,4) % &mul[3,7] ! @ ^ do\_not mul(5,5) + mul(32,64] then ( mul(11,8) mul(8,5) )  
8    25    88    40

Listing 1: Example '1' (visualization)

Result: 187825547

## Puzzle 2

Example '2' passes

Result: 85508223

## Day 4★★

### Puzzle 1

Example passes

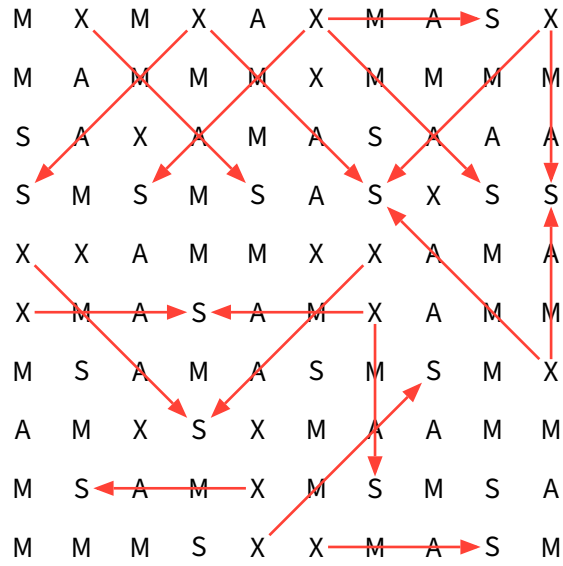

Figure 3: Example (visualization)

Result: 2654

### Puzzle 2

Example passes

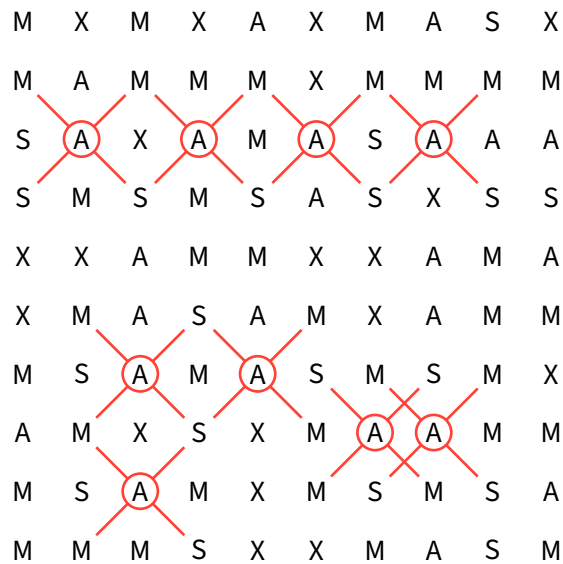

Figure 4: Example (visualization)

Result: 1990

## Day 5 ★★

### Puzzle 1

Example passes

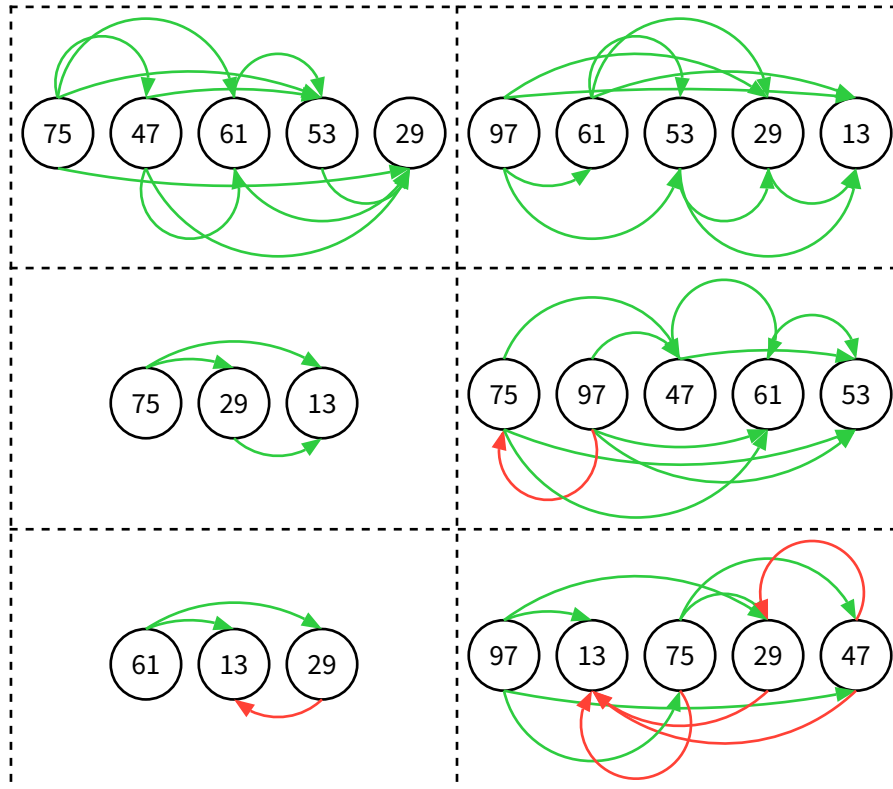

Figure 5: Example (visualization)

Result: 5374

### Puzzle 2

Example passes

Result: 4260

## Day 6 ★★

### Puzzle 1

Example passes

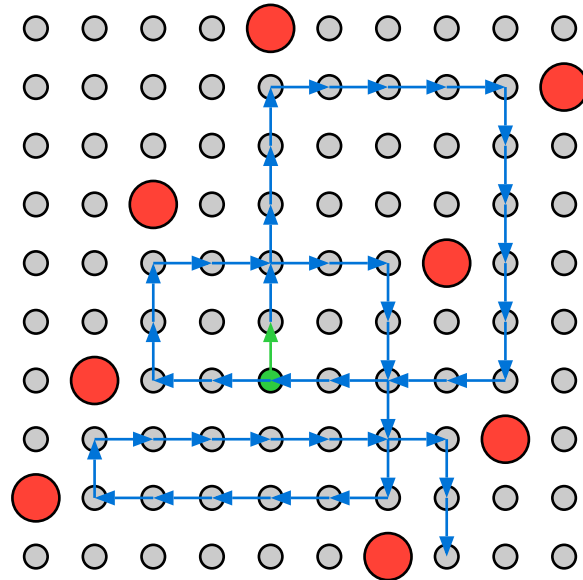

Figure 6: Example (visualization)

Result: 4752

### Puzzle 2

Example passes

Result: 1719



# Day 7★★

## Puzzle 1

Example passes

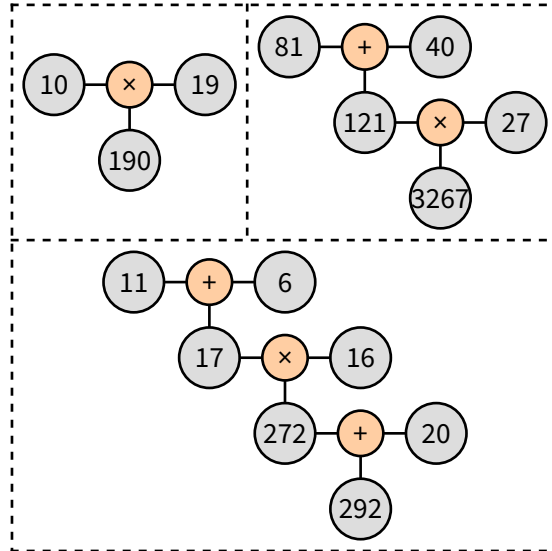

Figure 7: Example (visualization)

Result: 850435817339

## Puzzle 2

Example passes

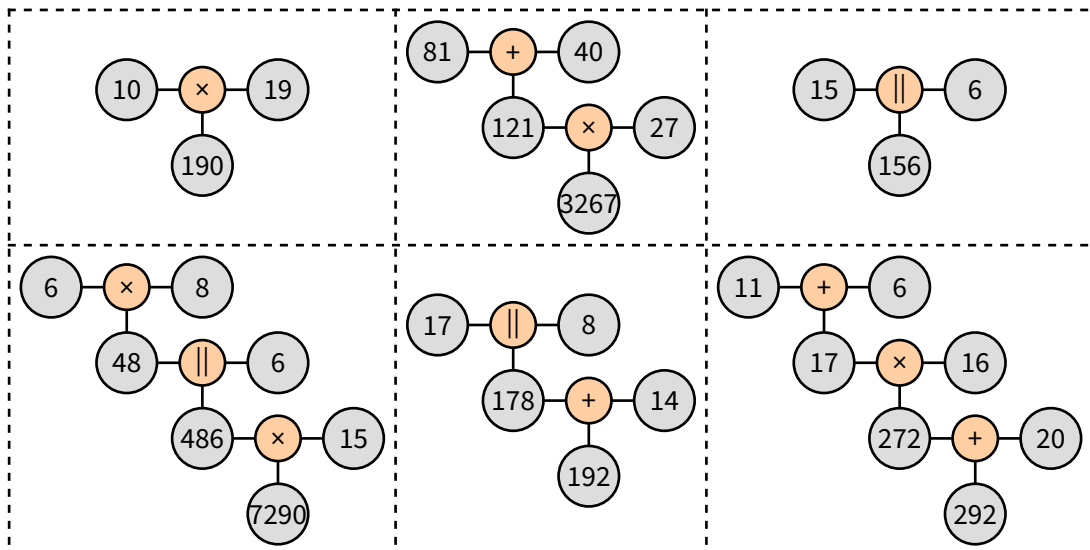

Figure 8: Example (visualization)

Result: 104824810233437

## Day 8 ★★

### Puzzle 1

Example passes

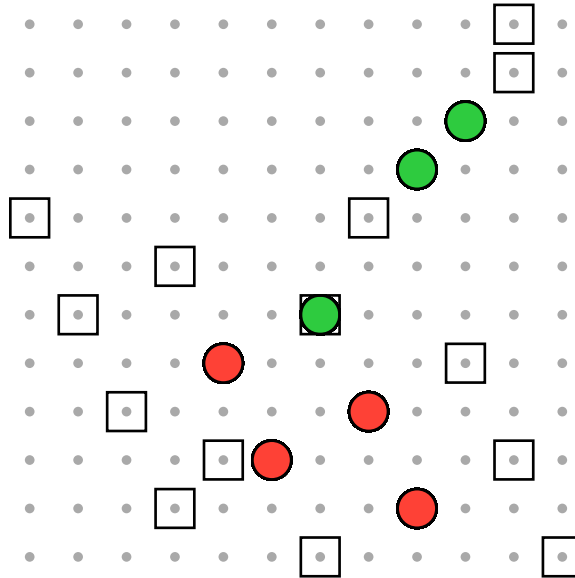

Figure 9: Example (visualization)

Result: 265

### Puzzle 2

Example passes

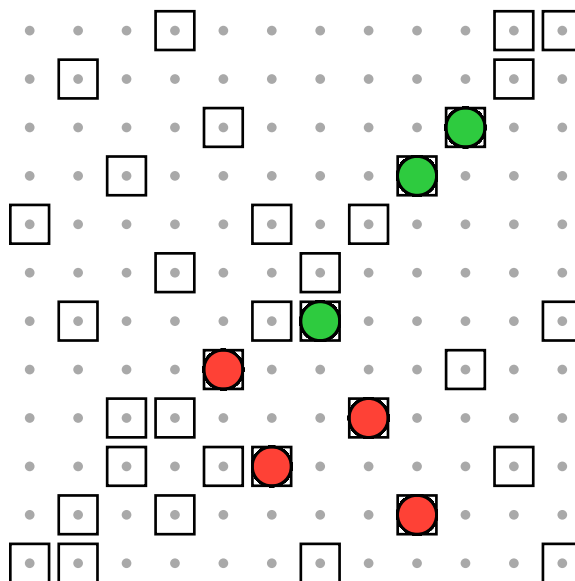

Figure 10: Example (visualization)

Result: 962

# Day 9☆☆

## Puzzle 1

Example '1' passes

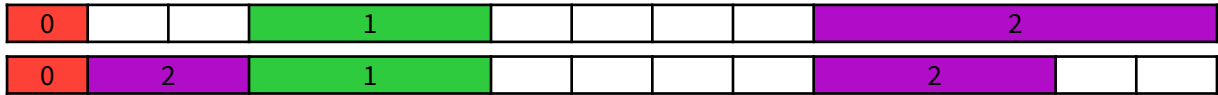

Figure 11: Example '1' (visualization)

Example '2' passes

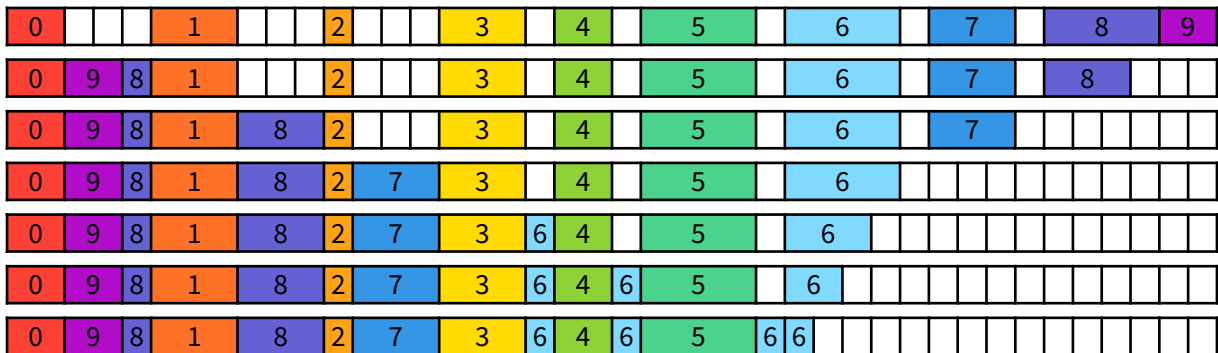

Figure 12: Example '2' (visualization)

Result: 6390180901651

## Puzzle 2

Example '1' passes

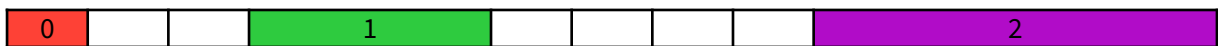

Figure 13: Example '1' (visualization)

Example '2' passes

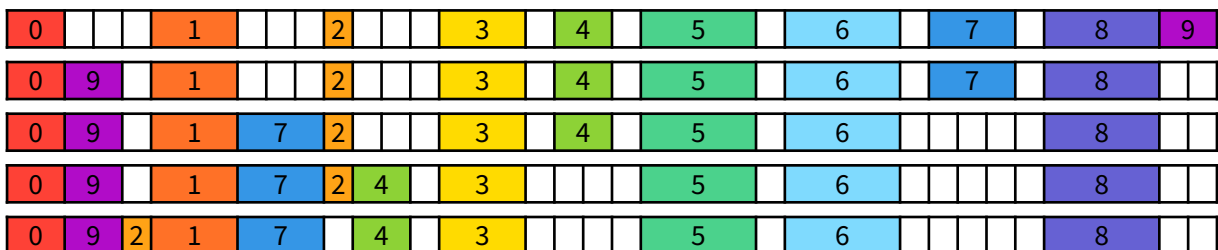

Figure 14: Example '2' (visualization)

Result: 6412390114238

**Day 10** ★★

**Puzzle 1**

Example passes

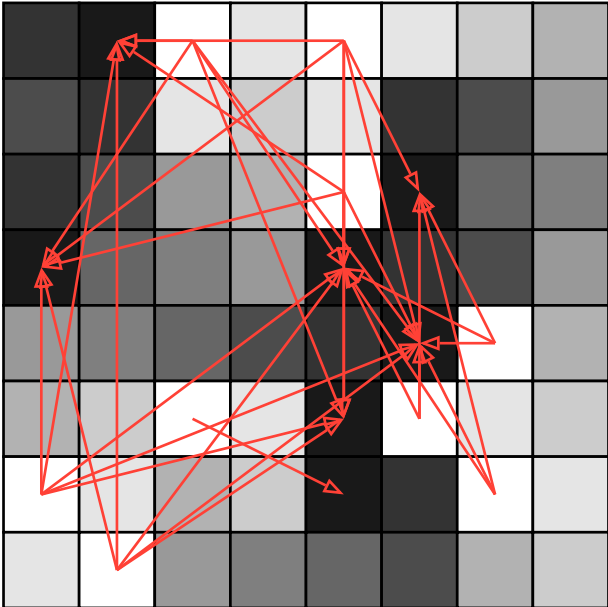

Figure 15: Example (visualization)

Result: 825

**Puzzle 2**

Example passes

Result: 1805

## Day 11 ★★

### Puzzle 1

Example passes

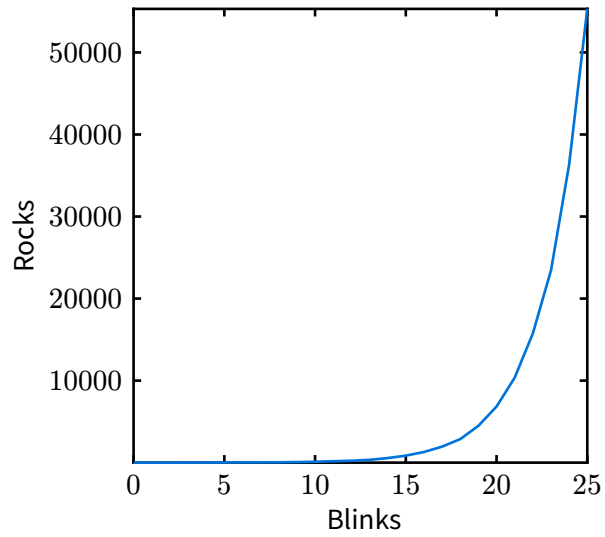

Figure 16: Example (visualization)

Result: 191690

### Puzzle 2

Result: 228651922369703

## Day 12 ★★

### Puzzle 1

Example '1' passes

Example '2' passes

Example '3' passes

Result: 1450422

### Puzzle 2

Example '1' passes

Example '2' passes

Example '3' passes

Example '4' passes

Example '5' passes

Result: 906606

## Day 13 ★★

### Puzzle 1

Example passes

Result: 29438

### Puzzle 2

Example passes

Result: 104958599303720

## Day 14 ★★

### Puzzle 1

Example passes

Result: 230436441

### Puzzle 2

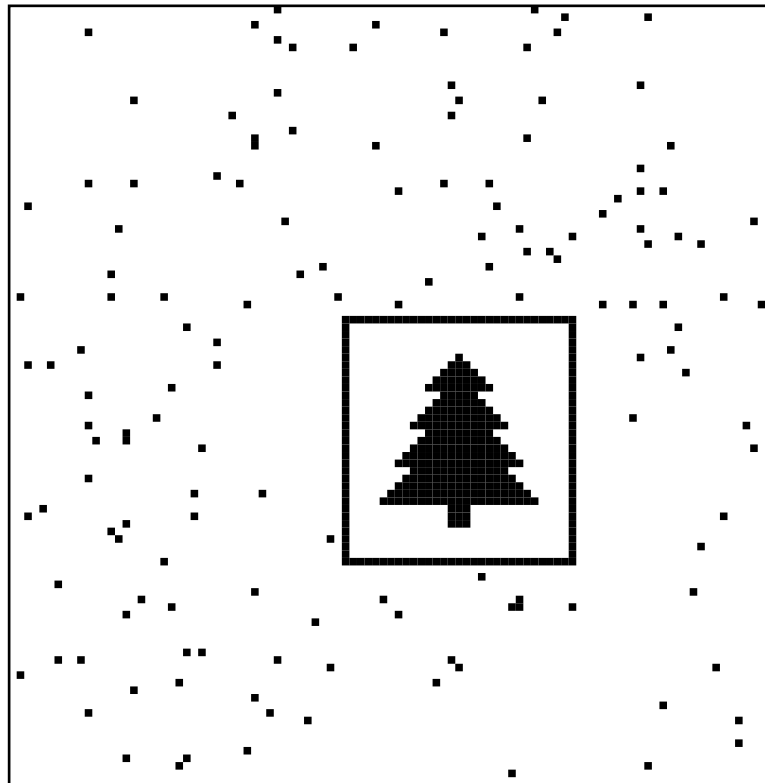

Figure 17: Christmas tree easter egg

Result: 8270



## Day 15 ★★

### Puzzle 1

Example '1' passes

Example '2' passes

Result: 1526018

### Puzzle 2

Example '2' passes

Result: 1550677

## Day 16

### Puzzle 1

Example '1' fails

Expected '7036' got '0'

Example '2' fails

Expected '11048' got '0'

Result: 0

### Puzzle 2

## Day 17★

### Puzzle 1

Example '1' passes

Result: "2,7,6,5,6,0,2,3,1"

### Puzzle 2

Example:

0,3,5,4,3,0

ADV: A >>= 3

OUT: OUT(A & 0b111)

JNZ: IF A != 0 {PC = 0}

Input:

2,4,1,5,7,5,1,6,4,2,5,5,0,3,3,0

BST: B = A & 0b111

BXL: B ^= 5

CDV: C = A >> B

BXL: B ^= 6

BXC: B ^= C

OUT: OUT(B & 0b111)

ADV: A >>= 3

JNZ: IF A != 0 {PC = 0}

## Day 18 ★★

### Puzzle 1

Example passes

O	O		#	O	O	O
	O	#	O	O	#	O
	O	O	O	#	O	O
			#	O	O	#
		#	O	O	#	
	#		O	#		
#		#	O	O	O	O

Figure 18: Example (visualization)

Result: 290

### Puzzle 2

Example passes

Result: "64,54"

## Day 19 ★★

### Puzzle 1

Example passes

Result: 258

### Puzzle 2

Example passes

Result: 632423618484345

## Day 20★

### Puzzle 1

Example passes

Example passes

Example passes

Example passes

Example passes

Example passes

Example passes

Example passes

Example passes

Example passes

Example passes

Result: 1429

### Puzzle 2

## Day 21

### Puzzle 1

Example passes

Result: 170862

### Puzzle 2

## Day 22

### Puzzle 1

Example passes

Example passes

Example passes

Example passes

Example passes

Example passes

Example passes

Example passes

Example passes

Example passes

Result: 18261820068

### Puzzle 2



## Day 23 ★★

### Puzzle 1

Example passes

Result: 1344

### Puzzle 2

Example passes

Result: "ab,al,cq,cr,da,db,dr,fw,ly,mn,od,py,uh"